



REMOTE → ISLANDS

Everest WNEV-17 2500 CCP



Module:

2500



Refrigerant:

R744



Available options:

- double island (one evaporator per module)
- working temperature: from -25°C to -21°C
- electrical defrosting
- mechanical expansion valve for HFC; for R744 units electronic expansion valve
- 2 x NTC temperature probe
- siphoned condensate drains
- thermopane glass
- exposition: zinc-plated steel, powder coated in white (RAL 9003)
- color of the base – black (RAL 9005)
- bumper (optionally)
- without sidewalls – sidewalls optionally (for WNEV-07-1895G sidewalls integrated)
- LEDit lighting (optionally)



Everest WNEV-17 2500 CCP



Cross sections:

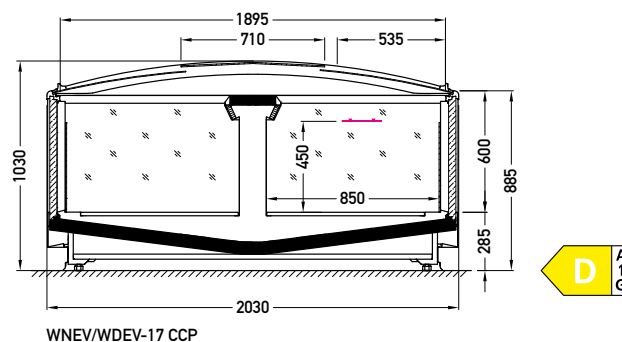

CCP – cover | single, curved | sliding (slide-up/push)

Available modules: 1875 2500 3750
1895G